



GREYSTONE ENERGY SYSTEMS INC

DUCT TEMPERATURE SENSOR TE200B Series

The B series single point rigid duct temperature sensor utilizes a precision sensor that is encapsulated in 6.35 mm (0.25") OD, 304 series stainless steel probe and is available in various lengths (see ordering chart) All probes provide excellent heat transfer, fast response and resistance to moisture penetration. It is available with a variety of enclosures.



SPECIFICATION:

- Sensor Type Thermistor or RTD
See Ordering Chart
- Temperature Range -20 to 105 °C (-4 to 221 °F)
Higher Ranges Available
Contact Greystone
- Wire Material PVC insulated, parallel bonded
(Type 2, 100 ohm platinum uses FT-4)
- Probe Material 304 Series Stainless Steel
- Probe Dimensions 0.25" (6.35 mm) Diameter
- Enclosure Standard - ABS - UL94-5VB - IP61 (NEMA 2)
Round (E) - ABS - UL94-5VB - IP65 (NEMA4X)
Metal (M) - Gal. Steel - IP50 (NEMA1)
Weatherproof (W) - Cast Alum. IP64 (NEMA3X)
*In order to maintain the published NEMA/IP ratings, properly rated conduit or cable gland adapters must be used.
- Termination Pigtail 2 or 3 wire
Terminal block with (E) enclosure

TYPICAL INSTALLATION:

For complete installation and wiring details, please refer to the product installation instructions.

The duct type probes are installed in the side of the duct to monitor a single point temperature within the duct. Select a probe length that allows the probe to span the duct width. Install the probe in a straight section of duct at a suitable distance downstream from any heating, cooling or humidification devices.

Each enclosure style provides mounting tabs on the outside of the enclosure for ease of installation.

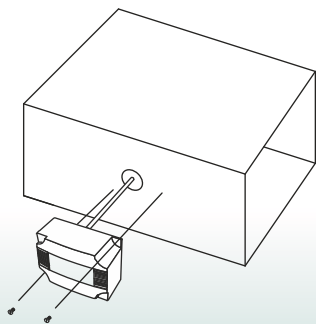

PART NUMBER SELECTED

PRODUCT SELECTION INFORMATION:

MODEL	Product Description
TE200B	Duct Temperature Sensor

CODE	Enclosure (ABS enclosure is standard)
-	ABS enclosure, standard (no code required, leave blank)
E	Round ABS, w/gasketed cover
M	Metal utility box
W	Aluminum weatherproof box

CODE	Sensor
2	100 Ω Platinum, IEC 751, 385 Alpha, thin film
5	1801 Ω, NTC Thermistor, ±0.2 C
6	3000 Ω, NTC Thermistor, ±0.2 C
7	10,000 Ω, Type 3, NTC Thermistor, ±0.2 C
8	2.252 KΩ, NTC Thermistor, ±0.2 C
12	1000 Ω Platinum, IEC 751, 385 Alpha, thin film
13	1000 Ω Nickel, Class B, DIN 43760
14	10,000 Ω, Type 3, NTC Therm., ±0.2 C c/w 11K shunt resistor
20	20,000 Ω, NTC Thermistor, ±0.2 C
24	10,000 Ω, Type 2, NTC Thermistor, ±0.2 C

CODE	Probe Length
A2	50 mm (2")
B2	100 mm (4")
C2	150 mm (6")
D2	200 mm (8")
E2	300 mm (12")
F2	450 mm (18")

Dimensions:

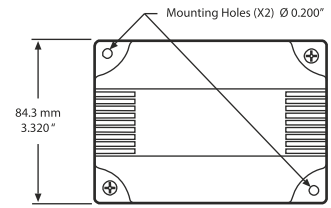
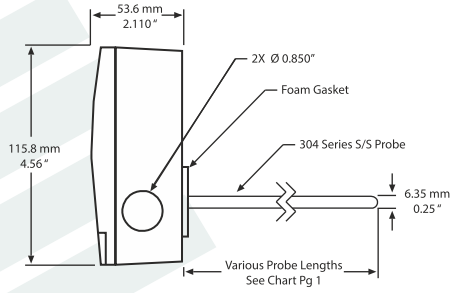
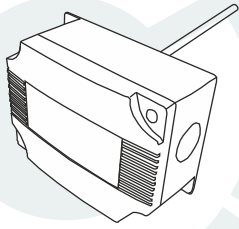

ABS Enclosure

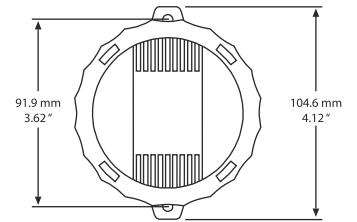
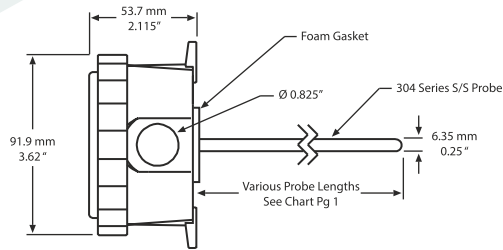
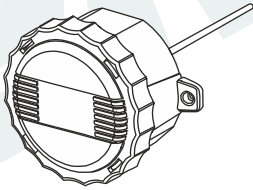

Round ABS Enclosure (E)

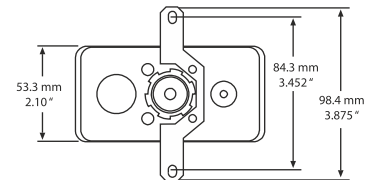
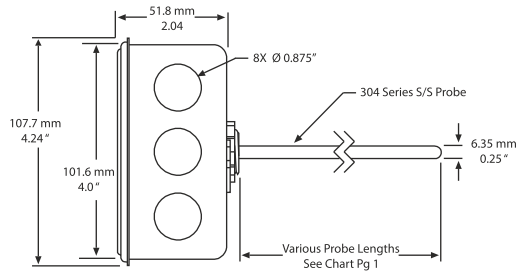
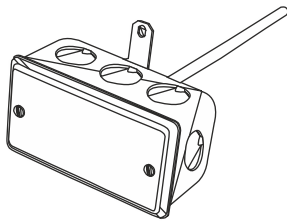

Metal Enclosure (M)

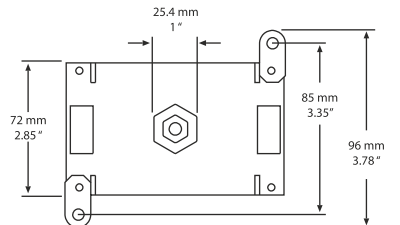
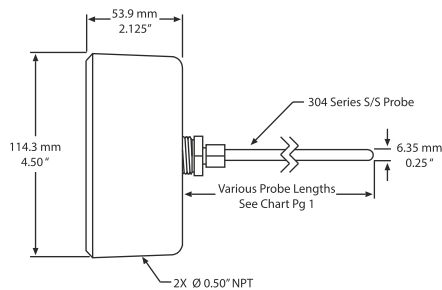
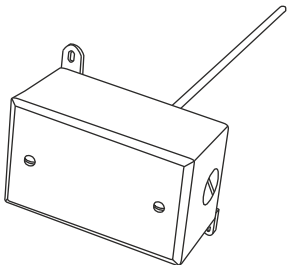

Weatherproof Enclosure (W)

Greystone Energy Systems, Inc. reserves the right to make design modifications without prior notice.